



Aquion Battery and SMA Sunny Island Inverter Installation Manual



Aquion Energy, Inc.
32 39th Street
Pittsburgh, PA 15201
+1 412.904.6400
aquionenergy.com

AQ-OP-00023_A

© 2016 Aquion Energy, Inc.

The information in this document is subject to periodic updates and changes. Upon any updates or changes to the above-described material, Aquion Energy will provide new drawings and/or associated documentation that will supersede those contained in this document. Contents are subject to change without notice.

For the latest product documentation, visit <http://aquionenergy.com/documentation> or email us at info@aquion-energy.com.

Warnings in This Document



CAUTION

CAUTION indicates a situation that, if not avoided, could damage equipment.



ATTENTION

ATTENTION indicates information that is important but not critical to safety.

Table of Contents

1	Introduction	1
1.1	About This Manual	1
1.2	Contact Information	1
2	Battery Bank Sizing for Sunny Island Inverters	2
3	Parts Required	3
3.1	Unsensed Battery Systems	3
3.2	Sensed battery systems	4
4	Installation with the BMS-200	5
4.1	Before You Begin	5
4.2	Installation Instructions	5
4.3	Inverter Settings	10
4.3.1	Settings for Sunny Island 3.0M / 4.4M and Sunny Island 6.0H / 8.0H with a BMS	10
4.3.2	Settings for Sunny Island 4548-US/6048-US with a BMS	11
5	Installation without a BMS-200	12
5.1	Inverter Settings	12
5.1.1	Settings for Sunny Island 3.0M / 4.4M and 6.0H / 8.0H without a BMS	12
5.1.2	Settings for Sunny Island 4548-US/6048-US without a BMS	13
6	BMS-200 and System Operation	14
7	Contact Us for More Information	15
8	Legal/Disclaimer/Warranty	15

1 Introduction

1.1 About This Manual

This document describes how to use SMA Sunny Island inverters with Aquion batteries and the Aquion Battery Monitoring System (BMS-200). This manual applies to the following models of Aquion battery and SMA Sunny Island inverter:

- + Aquion battery stacks: S20-P08F, S20-P080, S30-0080, Aspen 48S
- + Aquion battery modules: M100-LS82P, M100-L082P, M110-L083, M110-LS83, Aspen 48M
- + Sunny Island inverters: 3.0M/4.4M, 6.0H/8.0H, 4548-US/6048-US

Aquion batteries have been officially supported by SMA since June 2015:

blog.aquionenergy.com/press-release-aquion-energy-batteries-now-officially-supported-by-sma.

The inverter settings in this application note are meant to better match the performance of the Aquion Energy batteries to the capabilities of the SMA inverters and maximize the usable system performance. Each project has its own variables that must be accounted for when setting inverter parameters. Carefully review the settings and ensure they are appropriate for your application.

1.2 Contact Information

Mail: Aquion Energy
32 39th Street
Pittsburgh, PA 15201

Telephone: +1 412.904.6400

Web: aquionenergy.com

2 Battery Bank Sizing for Sunny Island Inverters

SMA Sunny Island inverters do not have the ability to limit the discharge current/power of the batteries. Depending on the application, they can try to draw as much as their peak current rating from the batteries. The battery bank must be sized to handle the peak without having its voltage drop below the inverter minimum voltage limit.

The table below shows the minimum number of battery stacks needed to meet a single inverter's continuous power rating, when operating in grid-tied/self-consumption mode, or peak power rating, when operating in off-grid mode, down to 25% SOC. Be sure to multiply the number of battery stacks by three for three-phase systems.

Sunny Island model (region)	Inverter continuous power (W)	Inverter peak power (W), 5 sec/30 min	Min. num. S20-P stacks		Min. num. S30 stacks		Min. num. Aspen 48S stacks	
			Grid-tied, self-consumption	Off-grid or backup	Grid-tied, self-consumption	Off-grid or backup	Grid-tied, self-consumption	Off-grid or backup
3.0M (MOW)	2,300	5,500/3,000	4	9	4	8	3	8
4.4M (MOW)	3,300	5,500/4,400	6	9	5	8	5	8
6.0H (MOW)	4,600	11,000/6,000	8	18	7	17	7	16
8.0H (MOW)	6,000	11,000/8,000	10	18	9	17	9	16
4548 (U.S.)	4,500	11,000/5,300	N/A	18	N/A	17	N/A	16
6048 (U.S.)	5,750	11,000/7,000	N/A	18	N/A	17	N/A	16

Be aware that some loads, such as electric motors, can draw five to six times their rated current when first starting. For example, appliances such as HVAC units, refrigerators, and freezers have compressors that are driven by electric motors. When sizing your system, it is very important to consider the starting current and power of such devices (sometimes called inrush current), not just their rated current and power.

Aquion also recommends notifying the homeowner about the maximum power capability of their energy storage system. While adding some loads to the system might be possible later on, they should always consult the installer before doing so. It might be necessary to add more batteries.

More information about sizing systems with Aquion batteries can be found in Aquion's application note on system sizing (<http://aquion.energy/2bVXNCu>). It covers off-grid and grid-tied applications, and it is a critical read before designing and installing an energy storage system.

Do not hesitate to contact your distributor or Aquion Energy if you need any assistance with sizing.

3 Parts Required

The BMS-200 outputs CANbus traffic via its DeviceNet port or USB port. The Sunny Island receives CANbus traffic through its ComSync or ComSync In pin connector, which is an RJ45 receptacle. Connecting the BMS-200 and the Sunny Island requires one of two adapters, which depends on which type of Aquion battery you have, summarized in the table below and detailed in the following sections.

	BMS-200	Sunny Island Hyper Cable	Current sensor (NOT available from Aquion)	Sunny Island Interface Device
Unsensed batteries	Required	Required	Required	
Sensed batteries	Required			Required

3.1 Unsensed Battery Systems

Unsensed Aquion batteries are battery modules with "L0" in their model number or battery stacks. These batteries have no equipment to sense and communicate battery voltage, current, and temperature.

In systems of unsensed Aquion batteries, the BMS-200 outputs CANbus traffic over its DeviceNet CANbus port. These systems require the following accessories (one of each per inverter):

- + *Sunny Island Hyper Cable*: Connects the CANbus output of the BMS-200's DeviceNet port to the Sunny Island's RJ45 ComSync or ComSync In port. **Aquion provides this part.**



Sunny Island Hyper Cable

- + *Current sensor*: Enables the Sunny Island to measure battery current via a current shunt. **Aquion DOES NOT supply this part.** See the Sunny Island manual for information on the current sensor selection, installation, configuration, and calibration.



Example current shunt

Sunny Island (4548-US / 6048-US shown)

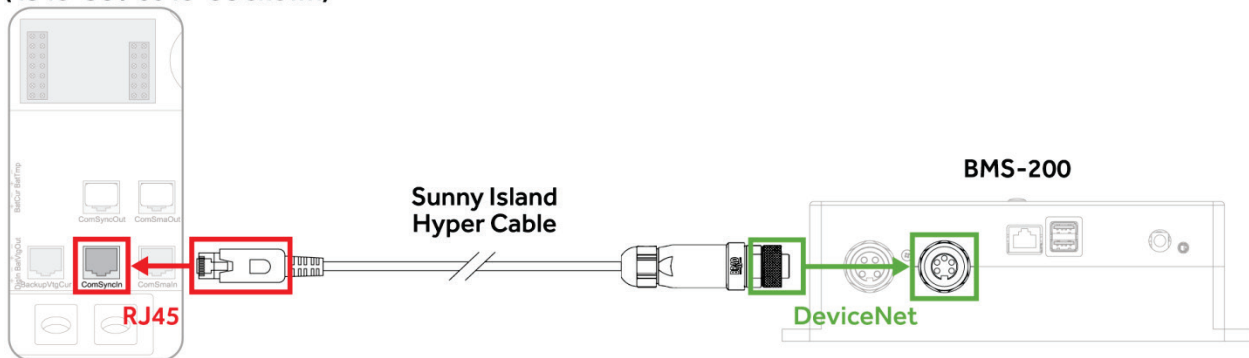

3.2 Sensed battery systems

Sensed Aquion batteries are battery modules with "LS" in their model number. They have an integrated sensing board that measures the voltage, current, and temperature of the battery and relays that data to the BMS-200 as CANbus traffic via a DeviceNet cable, which occupies the BMS-200's DeviceNet port. This leaves the BMS-200's USB port for CANbus output to the inverter. Converting from the BMS-200's USB port to the Sunny Island's RJ45 pin connector requires a special adapter (one per inverter):

- + *Sunny Island Interface Device*: Connects the CANbus output of the BMS-200's USB port to the Sunny Island's RJ45 ComSync or ComSync In port. **Aquion provides the Sunny Island Interface Device**, which consists of three parts:

- CAT5 Ethernet cable with RJ45 connectors, 5 ft.
- Pre-assembled adapter: USB-to-CAN adapter, 120-ohm CANbus terminator, DB9-to-CAT5 adapter with 100-ohm terminator
- Mini-USB cable, 6 ft.



Sunny Island Interface Device

Sunny Island (4548-US / 6048-US shown)

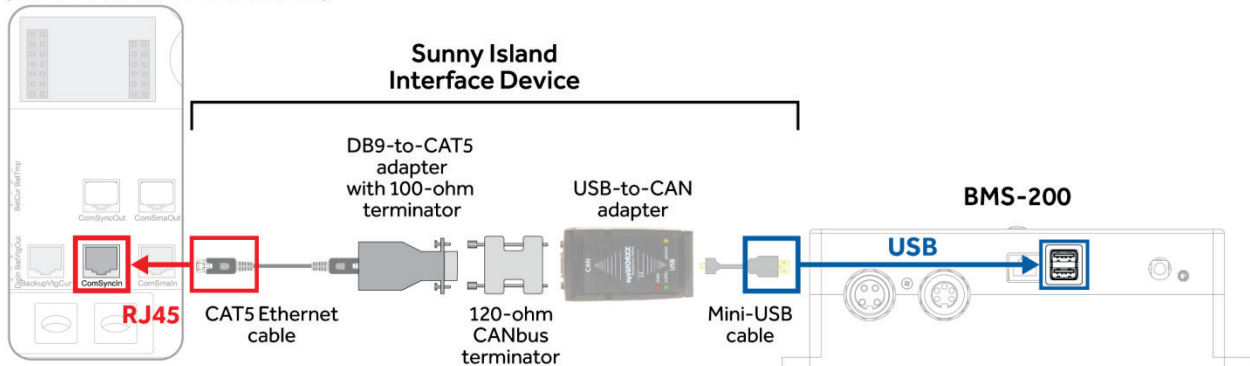

4 Installation with the BMS-200

4.1 Before You Begin

Ensure you have the right version of the Sunny Island's firmware:

Model	Firmware Version	Where to Get the Firmware
Sunny Island 3.0M / 4.4M	3.2xx	https://www.sma.de/en/service/downloads.html
Sunny Island 6.0H / 8.0H	3.1xx	https://www.sma.de/en/service/downloads.html
Sunny Island 4548-US / 6048-US	7.303	Contact Aquion

Read the product specifications and manuals:

Aquion Products: http://aquionenergy.com/documentation	SMA Products: https://www.sma.de/en/service/downloads.html
BMS-200 Product Specification Sheet	Installation Manual - SUNNY ISLAND 3.0M / 4.4 M / 6.0H / 8.0H
BMS-200 Installation & Operation Manual	Operating Manual - SUNNY ISLAND 4548-US / 6048-US
Specification sheets for your Aquion battery model	
Installation & Operation Manual for your battery model	

4.2 Installation Instructions



ATTENTION

At set-up, the BMS-200 should be connected to the internet so that it can receive the latest firmware update. If internet connection is not possible, contact Aquion Technical Support before installation. For optimal battery system performance, Aquion strongly recommends always keeping the BMS-200 connected to the internet during operation so that it can receive firmware updates and upload system performance logs for remote diagnostics.

1. Install all batteries and power control electronics according to the manufacturers' instructions.
2. Ensure all equipment is powered down and in a safe state for servicing. Follow the safety information in the Sunny Island and Aquion product manuals.
3. Mount the BMS-200 no more than 3 m away from the Sunny Island.
4. Power the BMS-200.
 - *Off-grid*: Connect the BMS-200 power supply to an uninterrupted power supply (UPS) capable of delivering at least 220 W. This will allow the BMS-200 to boot, set up, and begin communicating SOC, which the Sunny Island needs to operate.
 - *Grid-tied*: Connect the BMS-200 to a properly grounded power outlet (follow the set-up instructions in the BMS-200 Installation & Operation Manual, Section 4.4, steps 1–3).

5. Set up the BMS-200 by running the Installation Wizard.

ATTENTION

The total length of the communication bus must not exceed 30 m. The communication bus may connect several nodes, such as additional Sunny Island inverters. Check the Sunny Island manual for correct installation.

→ For sensed LS modules with Sunny Island Interface Device: Follow the set-up instructions in the BMS-200 Installation & Operation Manual (Section 4.4, step 4). Then return to this manual (Aquion Battery and SMA Sunny Island Inverter Installation Manual) and continue to step 6.

→ For stacks/unsensed L0 modules with current sensor and Sunny Island Hyper Cable: Follow the instructions below.

- a. Select "S-Line Battery Stacks" as your product type, *even if you have unsensed, L0 modules*. The Wizard assumes that all modules are sensed, LS models. Select your battery model and click "Next."

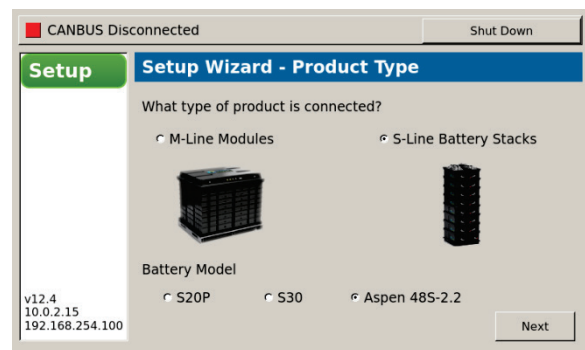

- b. Choose "SMA" as your inverter and click "Next."

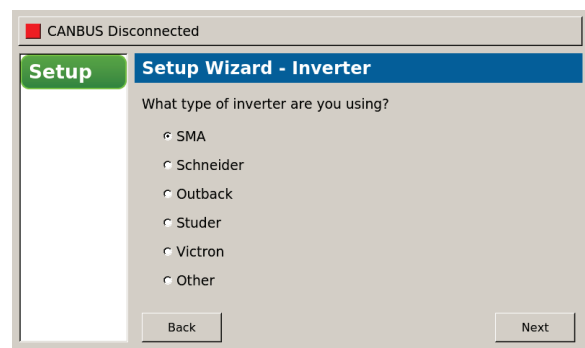

- c. Select "SMA CANBUS Interface" and click "Next."

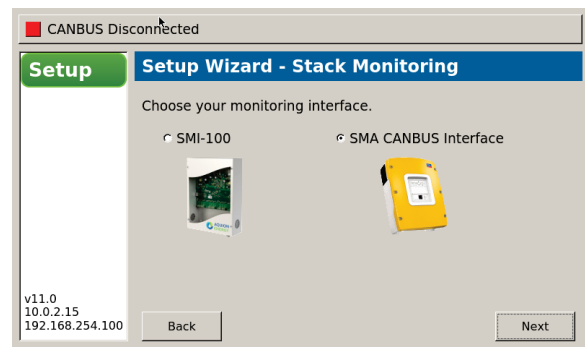

- d. Select the total number of battery stacks to be connected to the BMS-200. For every L0 battery module, enter 12 battery stacks. Click "Next."

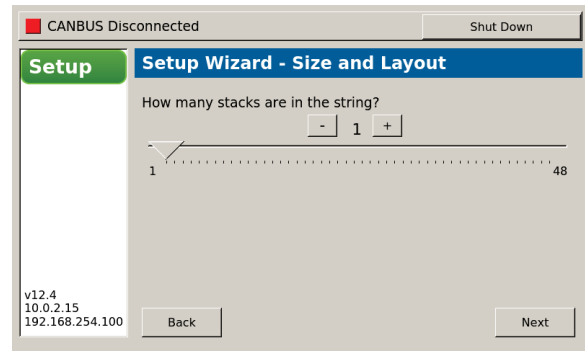

- e. The Setup Wizard will install the BMS-200 firmware. If the BMS-200 is connected to the internet, the Setup Wizard will download the newest firmware and install it. If not, the Setup Wizard will install the firmware version saved in the BMS unit. When complete, click "Finished." The set-up will complete, and the system will reboot to the Home screen.

CAUTION

Disconnecting power before the BMS-200 reboots and displays the Home screen could damage the BMS-200.

6. Connect the Sunny Island Hyper Cable or Sunny Island Interface Device to the BMS-200.

→ For stacks/unsensed L0 modules with current sensor and Sunny Island Hyper Cable:

- Install the battery current sensor according to the instructions in the Sunny Island manual. Aquion does not supply a current sensor. See the Sunny Island manual for information on the current sensor installation, configuration, and calibration.
- Plug the CANbus connector of the Sunny Island Hyper Cable into the CAN OUT port of the BMS-200.

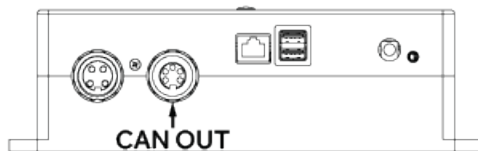

→ For sensed LS modules with Sunny Island Interface Device:

- Assemble the Sunny Island Interface Device.
- Plug the Sunny Island Interface Device's USB cable into either USB port of the BMS-200. Ensure that the pre-assembled adapter and mini-USB cable are properly supported to prevent accidental disconnection.

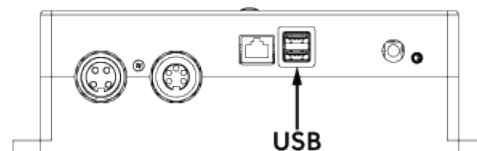

7. Connect the BMS-200 to the Sunny Island.

- a. Plug the RJ45 end of the Sunny Island Hyper Cable or Sunny Island Interface Device into the ComSync or ComSync In port of the Sunny Island.

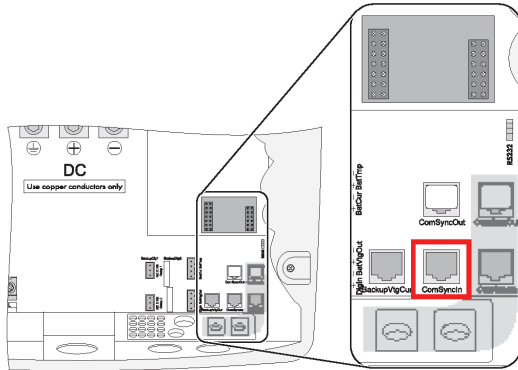

ComSync In pin connector of the SMA Sunny Island 4548-US / 6048-US.

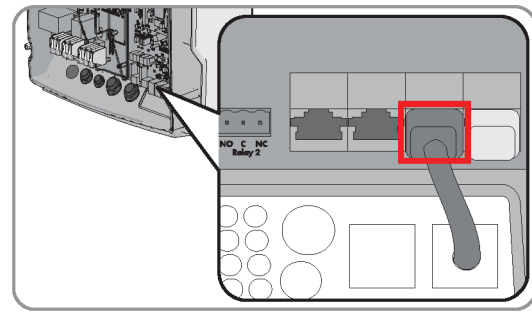

ComSync pin connector of the SMA Sunny Island 3.0M / 4.4M and 6.0H / 8.0H.

-
- b. Insert an SMA CANbus terminator into the open ComSync port. Refer to the Sunny Island manual for CANbus termination instructions.

8. Replace the Sunny Island cover.

9. Power on and initialize the Sunny Island.

→ *If updating an existing Aquion system:*

- a. Initialize a "New Battery" in the Sunny Island inverter, according to the Sunny Island manual.
- b. Set the battery type as "Lilon_Ext-BMS."
- c. Set the amp hours according to property 221.02 in Section 4.3.1 or 4.3.2.
- d. Verify that battery settings conform to the values presented in Section 4.3.1 or 4.3.2.
- e. If using the Sunny Island Hyper Cable, re-calibrate the current sensor via the Sunny Island menu.

→ *If installing a new Aquion system:* Follow the directions in the SMA Sunny Island manual for a new system. Set the battery type as Lilon_Ext-BMS and all other settings as described below in Section 5.1.1 or 5.1.2.

⚠ ATTENTION

The BMS displays charge current as positive and discharge current as negative. The Sunny Island displays the reverse: charge current as negative and discharge current as positive.

10. Allow the system to operate for approximately 10 hours to calibrate the SOC calculation.

The BMS-200 requires the battery to be fully charged one time to correctly calculate SOC.

→ For stacks/unsensed L0 modules with current sensor and Sunny Island Hyper Cable:

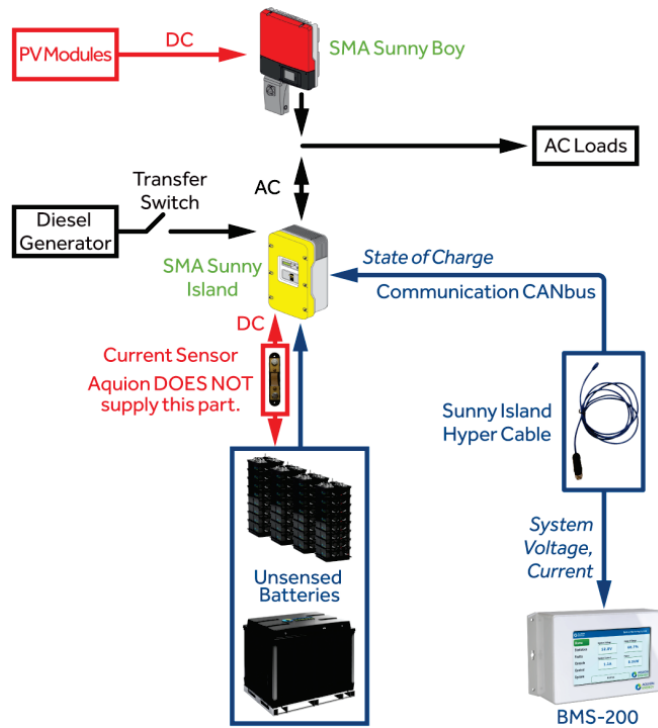

→ For sensed LS modules with Sunny Island Interface Device:

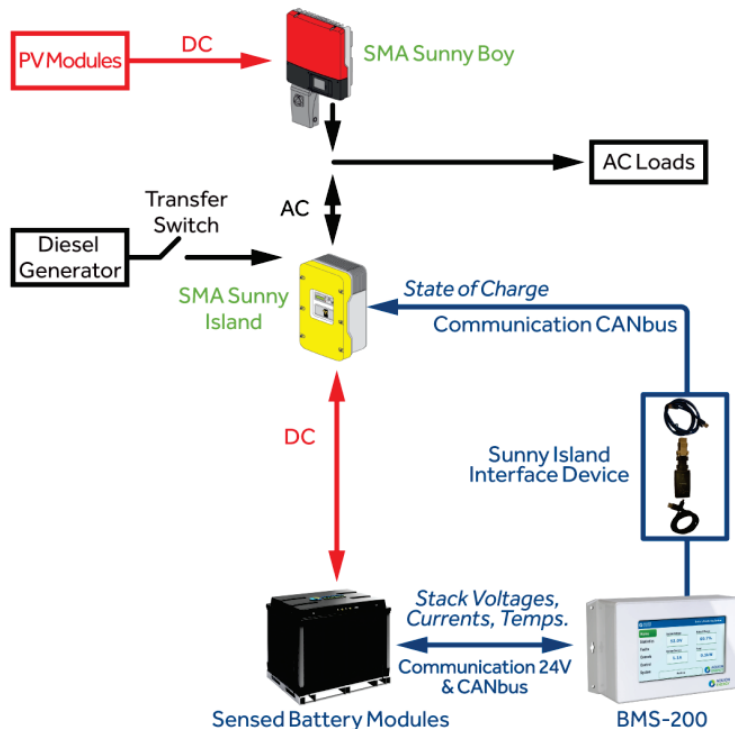

Example systems of battery stacks and unsensed L0 modules (top) or sensed LS modules (bottom). Equipment models may vary.

4.3 Inverter Settings

4.3.1 Settings for Sunny Island 3.0M / 4.4M and Sunny Island 6.0H / 8.0H with a BMS

#	Setting Name	GRID-TIED (self-consumption)	OFF-GRID
		Value	Value
221# Property			
221.01	BatTyp	Lilon_Ext-BMS	Lilon_Ext-BMS
221.02	BatCpyNom	40 Ah/stack -OR- 480 Ah/module*	40 Ah/stack -OR- 480 Ah/module*
221.03	BatVtgNom	48 V	48 V
222# Chagemode			
222.01	BatChrgCurMax	S20-P/M100-Lx82P, S30/M110: Up to 17 A/stack -OR- 204 A/module Aspen 48S/48M: Up to 20 A/stack -OR- 240 A/module	S20-P/M100-Lx82P, S30/M110: Up to 17 A/stack -OR- 204 A/module Aspen 48S/48M: Up to 20 A/stack -OR- 240 A/module
223# Protection			
223.05	BatPro1Soc	N/A	User preference (less than Generator or Grid SOC Start)
223.06	BatPro2Soc	N/A	User preference (less than Generator or Grid SOC Start)
223.07	BatPro3Soc	N/A	User preference (less than Generator or Grid SOC Start)
224# BatSilent			
224.01	BatSilentEna	N/A	Enable
224.02	BatSilentTmFlo	N/A	4 hr
224.03	BatSilentTmMax	N/A	48 hr
233# Grid Start			
233.08	GdPwrEna	N/A	Enable
233.09	GdPwrStr	N/A	User preference
233.10	GdPwrStp	N/A	User preference
235# Gen Start			
235.09	GnPwrEna	N/A	Enable
235.10	GnPwrStr	N/A	User preference
235.11	GnPwrStp	N/A	User preference
250# System - For three-phase systems only			
250.30	RnMod	RunAlways	RunAlways
261# General			
261.01	SlfCsmplncEna	Enable	N/A
261.02	SlfCsmpposSel	North or South	N/A
261.03	Saisonenable	Disable	N/A
262# BatUsage			
262.01	ProtResSOC	0%	N/A
262.02	BatResSOC	2%	N/A
262.03	BUResSOC	0%	N/A
262.04	PVResSOC	4%	N/A
262.05	MinSlfCsmpposSOC	75%	N/A

* C10 rate; see Sunny Island manual for more information.

4.3.2 Settings for Sunny Island 4548-US/6048-US with a BMS

#	Setting Name	GRID-TIED (backup)	OFF-GRID
		Value	Value
221# Property			
221.01	BatTyp	Lilon_Ext-BMS	Lilon_Ext-BMS
221.02	BatCpyNom	40 Ah/stack -OR- 480 Ah/module*	40 Ah/stack -OR- 480 Ah/module*
221.03	BatVtgNom	48 V	48 V
222# Chagemode			
222.01	BatChrgCurMax	S20-P/M100-Lx82P, S30/M110: Up to 17 A/stack -OR- 204 A/module Aspen 48S/48M: Up to 20 A/stack -OR- 240 A/module	S20-P/M100-Lx82P, S30/M110: Up to 17 A/stack -OR- 204 A/module Aspen 48S/48M: Up to 20 A/stack -OR- 240 A/module
223# Protection			
223.05	BatPro1Soc	N/A	User preference (less than Generator or Grid SOC Start)
223.06	BatPro2Soc	N/A	User preference (less than Generator or Grid SOC Start)
223.07	BatPro3Soc	N/A	User preference (less than Generator or Grid SOC Start)
224# BatSilent			
224.01	SilentEna	N/A	Enable
224.02	SilentTmFlo	N/A	4 hr
224.03	SilentTmMax	N/A	48 hr
235# Gen Start			
235.09	GnPwrEna	N/A	Enable
235.10	GnPwrStr	N/A	User preference
235.11	GnPwrStp	N/A	User preference
250# System - For three-phase systems only			
250.30	RnMod	RunAlways	RunAlways

* C10 rate; see Sunny Island manual for more information.

5 Installation without a BMS-200

Aquion does not recommend using our batteries and an SMA inverter without an Aquion BMS. While the inverter and batteries will be fully functional, the VRLA mode uses a lead acid SOC curve that will not allow the system to access the full capacity of Aquion batteries. See the application note "Power Electronics State of Charge Readings and Aquion Products" (<http://aquion.energy/23WrHtx>) for more information. Follow the installation steps from the Sunny Island manual as if you were installing lead acid (VRLA) batteries, and use the parameter settings presented in Section 5.1. For grid-tied applications without a BMS, contact Aquion technical support.

5.1 Inverter Settings

5.1.1 Settings for Sunny Island 3.0M / 4.4M and 6.0H / 8.0H without a BMS

OFF-GRID				
#	Setting Name	S20-P/M100-Lx82P	S30/M110	Aspen 48S/48M
221# Property				
221.01	BatTyp	VRLA	VRLA	VRLA
221.02	BatCpyNom	40 Ah/stack -OR- 480 Ah/module	40 Ah/stack -OR- 480 Ah/module	40 Ah/stack -OR- 480 Ah/module
221.03	BatVtgNom	48 V	48 V	48 V
222# Chagemode				
222.01	BatChrgCurMax	Up to 17 A/stack -OR- 204 A/module	Up to 17 A/stack -OR- 204 A/module	Up to 20 A/stack -OR- 240 A/module
222.02	AptTmBoost	60 min	60 min	60 min
222.03	AptTmFul	1 hr	4 hr	4 hr
222.04	AptTmEqu	1 hr	1 hr	1 hr
222.05	CycTmFul	180 days	180 days	180 days
222.06	CycTmEqu	180 days	365 days	365 days
222.07	ChrgVtgBoost	2.4 V	2.4 V	2.4 V
222.08	ChrgVtgFul	2.4 V	2.4 V	2.4 V
222.09	ChrgVtgEqu	2.4 V	2.4 V	2.4 V
222.10	ChrgVtgFlo	2.25 V	2.25 V	2.25 V
222.11	BatTmpCps	1 mV/cell/°C	1 mV/cell/°C	1 mV/cell/°C
222.12	AutoEquChrgEna	Disable	Disable	Disable
223# Protection				
223.05	BatPro1Soc	User preference (less than Generator or Grid SOC Start)	User preference (less than Generator or Grid SOC Start)	User preference (less than Generator or Grid SOC Start)
223.06	BatPro2Soc	User preference (less than Generator or Grid SOC Start)	User preference (less than Generator or Grid SOC Start)	User preference (less than Generator or Grid SOC Start)
223.07	BatPro3Soc	User preference (less than Generator or Grid SOC Start)	User preference (less than Generator or Grid SOC Start)	User preference (less than Generator or Grid SOC Start)
224# BatSilent				
224.01	BatSilentEna	Enable	Enable	Enable
224.02	BatSilentTmFlo	4 hr	4 hr	4 hr
224.03	BatSilentTmMax	48 hr	48 hr	48 hr
233# Grid Start				
233.08	GdPwrEna	Enable	Enable	Enable
233.09	GdPwrStr	User preference	User preference	User preference
233.10	GdPwrStp	User preference	User preference	User preference

(continues next page)

(continued) Settings for Sunny Island 3.0M / 4.4M and 6.0H / 8.0H without a BMS

OFF-GRID				
#	Setting Name	S20-P/M100-Lx82P	S30/M110	Aspen 48S/48M
235# Gen Start				
235.09	GnPwrEna	Enable	Enable	Enable
235.10	GnPwrStr	User preference	User preference	User preference
235.11	GnPwrStp	User preference	User preference	User preference
250# System - For three-phase systems only				
250.30	RnMod	RunAlways	RunAlways	RunAlways
261# General				
261.01	SlfCsmplncEna	N/A	N/A	N/A
261.02	SlfCsmpposSel	N/A	N/A	N/A
261.03	Saisonenable	N/A	N/A	N/A
262# BatUsage				
262.01	ProtResSOC	N/A	N/A	N/A
262.02	BatResSOC	N/A	N/A	N/A
262.03	BUResSOC	N/A	N/A	N/A
262.04	PVResSOC	N/A	N/A	N/A
262.05	MinSlfCsmpposSel	N/A	N/A	N/A

5.1.2 Settings for Sunny Island 4548-US/6048-US without a BMS

OFF-GRID				
#	Setting Name	S20-P/M100-Lx82P	S30/M110	Aspen 48S/48M
221# Property				
221.01	BatTyp	VRLA	VRLA	VRLA
221.02	BatCpyNom	40 Ah/stack -OR- 480 Ah/module	40 Ah/stack -OR- 480 Ah/module	40 Ah/stack -OR- 480 Ah/module
221.03	BatVtgNom	48 V	48 V	48 V
222# Chagemode				
222.01	BatChrgCurMax	Up to 17 A/stack -OR- 204 A/module	Up to 17 A/stack -OR- 204 A/module	Up to 20 A/stack -OR- 240 A/module
222.02	AptTmBoost	60 min	60 min	60 min
222.03	AptTmFul	1 hr	4 hr	4 hr
222.04	AptTmEqu	1 hr	1 hr	1 hr
222.05	CycTmFul	180 days	180 days	180 days
222.06	CycTmEqu	180 days	365 days	365 days
222.07	ChrgVtgBoost	2.4 V	2.4 V	2.4 V
222.08	ChrgVtgFul	2.4 V	2.4 V	2.4 V
222.09	ChrgVtgEqu	2.4 V	2.4 V	2.4 V
222.10	ChrgVtgFlo	2.17 V	2.25 V	2.25 V
222.11	BatTmpCps	1 mV/cell/°C	1 mV/cell/°C	1 mV/cell/°C
222.12	AutoEquChrgEna	Disable	Disable	Disable
233# Grid Start				
233.07	GdPwrStr	N/A	N/A	N/A
233.08	GdPwrStp	N/A	N/A	N/A
235# Gen Start				
235.09	GnPwrEna	Enable	Enable	Enable
235.10	GnPwrStr	User preference	User preference	User preference
235.11	GnPwrStp	User preference	User preference	User preference
250# System - For three-phase systems only				
250.30	RnMod	RunAlways	RunAlways	RunAlways

6 BMS-200 and System Operation

The BMS-200 provides the most accurate readings of battery voltage, current, state of charge (SOC), energy input, energy output, and charge/discharge limits to the system's inverter or site controller.

While using a BMS-200 is not necessary for most inverters, **Aquion strongly recommends using a BMS-200 with SMA Sunny Island inverters.** The Sunny Island bases all its system decisions on battery SOC, so an accurate SOC reading is fundamental for the proper operation of the system. Without a BMS-200 to provide the Sunny Island an accurate SOC reading, the SMA lead acid SOC algorithm may not allow the full capacity of Aquion batteries to be used.

The BMS-200 calculates SOC from the batteries' voltage, current, and temperature. How it is calculated depends on the type of battery.

→ *Sensed battery modules:*

A sensing board integrated into Aquion's sensed battery modules sends the voltage, current, and temperature values of each component battery stack to the BMS-200. The BMS-200 then calculates the SOC for each component battery stack. However, the Sunny Island can process only the entire system's SOC, which it receives from the BMS-200.

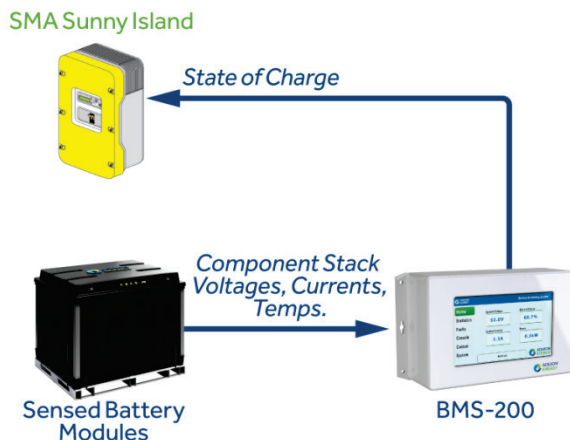

→ *Unsensed batteries:*

The Sunny Island senses the entire battery system's voltage and current and sends those values to the BMS-200. The BMS-200 calculates and returns the system's SOC, based on these values and an assumed battery temperature of 25°C.

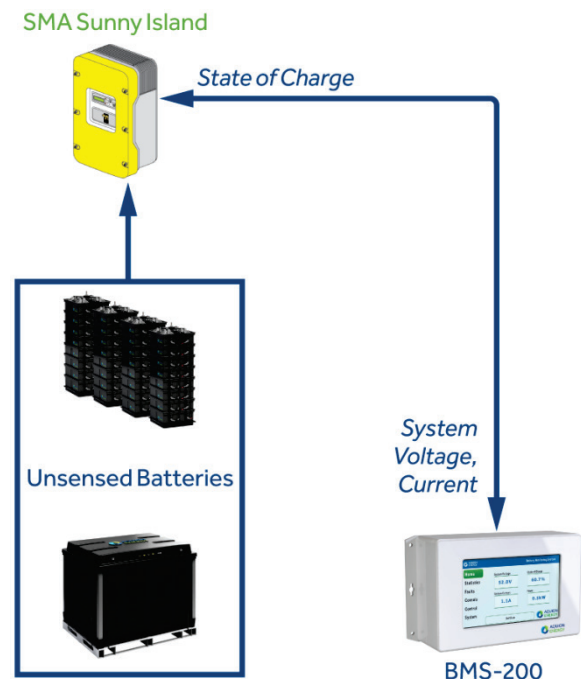

7 Contact Us for More Information

Contact Aquion Technical Support at support@aquion-energy.com.

8 Legal/Disclaimer/Warranty

COMPLYING WITH THE RECOMMENDATIONS SET FORTH IN THIS DOCUMENT WILL NOT NECESSARILY ACHIEVE OPTIMAL SYSTEM OR BATTERY PERFORMANCE, NOR GUARANTEE ANY SPECIFIC PERFORMANCE OR RESULTS. HOWEVER, FAILURE TO COMPLY WITH THESE INSTRUCTIONS MAY RESULT IN DIMINISHED PERFORMANCE, INCLUDING, BUT NOT LIMITED TO, REDUCING OVERALL SYSTEM LIFE. The information in this application note is provided "as is" without warranty of any kind, either express or implied, including, but not limited to, the implied warranties of fitness for a purpose, the warranty of non-infringement, or any warranties as to the information's accuracy or completeness. Aquion reserves the right to make changes to the information available at any time and assumes no liability for applications assistance, customer product design, or specific customer requirements. Nothing in this application note shall be construed as modifying any rights and obligations in the contract between the parties.